



INSTALLATION INSTRUCTIONS

PART NUMBER: RK-3938

This Assembly Fits: SEE CATALOG FOR CURRENT APPLICATIONS

Congratulations, you have purchased the finest custom air cleaner that money can buy. With proper care, this filter will last 1 million miles or more. This custom air cleaner replaces the stock air cleaner assembly. The following procedure **MUST** be followed to ensure a proper fit and seal of the custom air cleaner.

TOOLS NEEDED:

- Ratchet
- Extension
- 7/16" socket
- 3/8" hex key
- 5/16" hex key
- 3/32" hex key
- T27 TORX
- 7/16" wrench
- Flat Blade Screw Driver

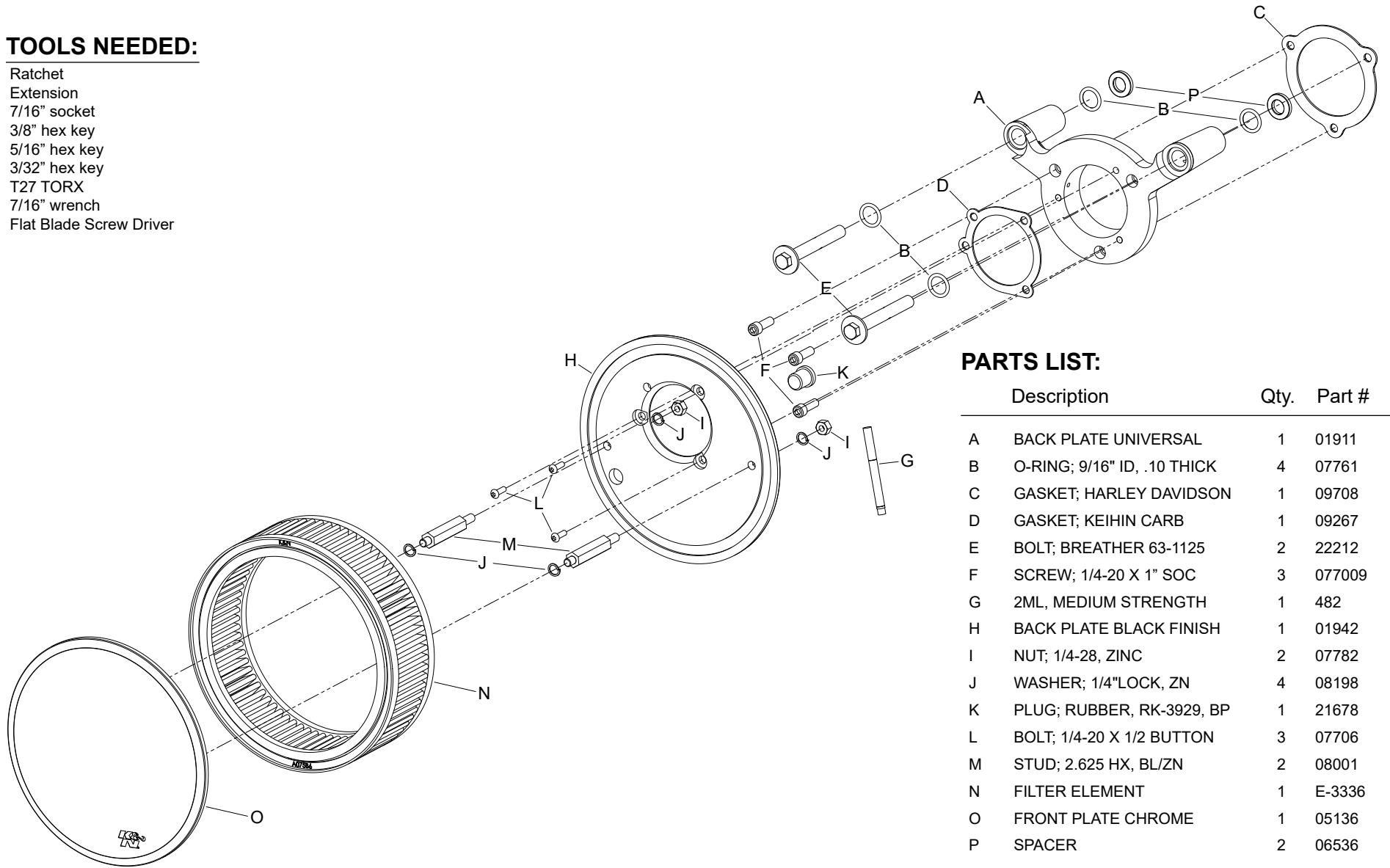

PARTS LIST:

Description	Qty.	Part #
A BACK PLATE UNIVERSAL	1	01911
B O-RING; 9/16" ID, .10 THICK	4	07761
C GASKET; HARLEY DAVIDSON	1	09708
D GASKET; KEIHIN CARB	1	09267
E BOLT; BREATHER 63-1125	2	22212
F SCREW; 1/4-20 X 1" SOC	3	077009
G 2ML, MEDIUM STRENGTH	1	482
H BACK PLATE BLACK FINISH	1	01942
I NUT; 1/4-28, ZINC	2	07782
J WASHER; 1/4" LOCK, ZN	4	08198
K PLUG; RUBBER, RK-3929, BP	1	21678
L BOLT; 1/4-20 X 1/2 BUTTON	3	07706
M STUD; 2.625 HX, BL/ZN	2	08001
N FILTER ELEMENT	1	E-3336
O FRONT PLATE CHROME	1	05136
P SPACER	2	06536

If you need any assistance please call 1-800-858-3333 to speak with a representative in our Customer Service Center before returning the product.

NOTE: FAILURE TO FOLLOW INSTALLATION INSTRUCTIONS AND NOT USING THE PROVIDED HARDWARE MAY DAMAGE THE INTAKE TUBE, THROTTLE BODY AND ENGINE.

TO START:

1. Turn off the ignition and disconnect the negative battery cable.



2. Remove the bolt securing the bonnet to the air filter and then remove the bonnet from the air filter.

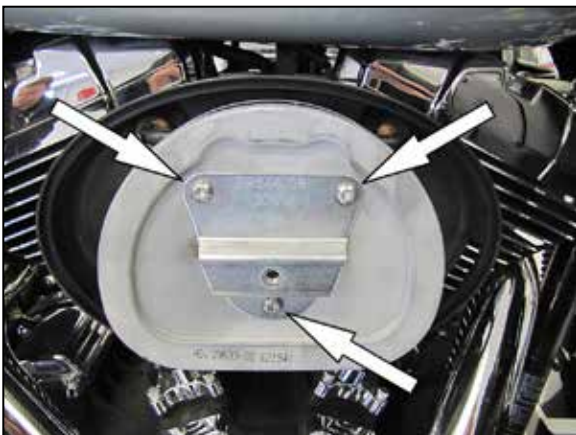

3. Remove the three bolts securing the air filter, then disconnect the crank case breather hoses and remove the air filter.

NOTE: K&N Engineering, Inc. recommends that customers do not discard the factory air intake components.

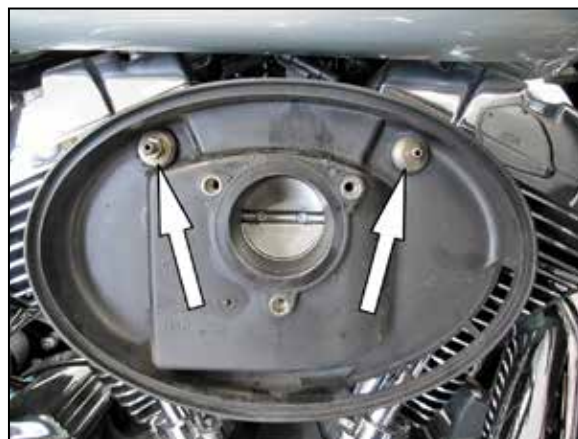

4. Remove the two breather bolts and then remove the inner air filter base.

NOTE: Unhook the wiring pigtail from the rear of the filter base. On non-US models, disconnect the intake valve solenoid.

NOTE: On non-US models, a by-pass module (sold separately) will need to be installed onto the pigtail to eliminate an engine management light from turning on. (non-US models only)



5. Install the four provided "O" rings into the K&N® base plate as shown.

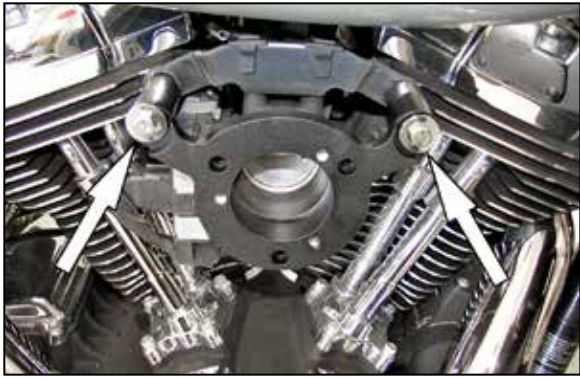

6. Install the K&N® adapter onto the engine and throttle body using the provided breather bolt.
NOTE: Do not completely tighten the breather bolts at this time. Take care while installing the adapter so that the “O” rings do not get pinched.

NOTE: On applications that have had the support bracket removed, install the two provided spacers between the back plate and cylinder head at the breather holes and then install the breather bolts as shown.



7. Apply one drop of the provided thread locker to the provided throttle body bolts.



8. Install the provided throttle body gasket and then install the throttle body bolts. Secure the adapter with the two breather bolts and three throttle body bolts.

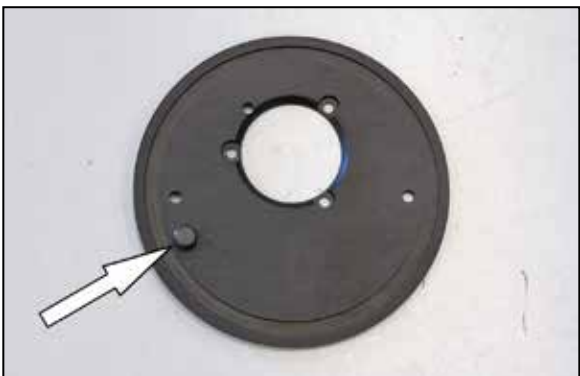

9. Install the provided rubber plug into the back plate from the back side as shown.



10. Apply one drop of the provided thread locker to the provided filter back plate mounting bolts.

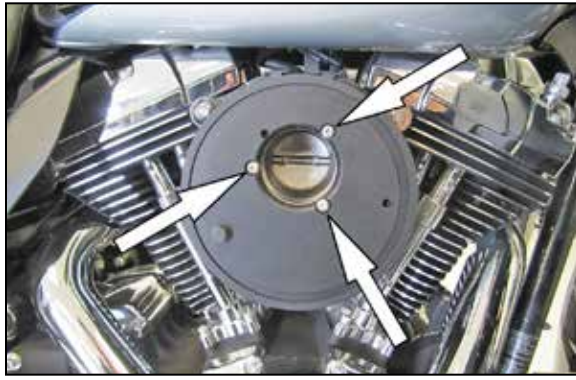

11. Install the filter back plate and gasket onto the adapter and secure with the provided bolts.

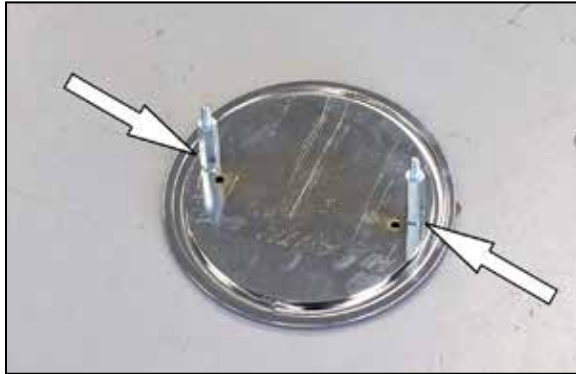

12. Install the provided mounting studs onto the front plate with the provided lock washers.



13. Install the K&N® air filter and front plate onto the back plate and secure with the provided hardware.

NOTE: It may be helpful to use a small screwdriver to position the filter into the grooves of the front and back plate while tightening the hardware.

14. Reconnect the vehicle's negative battery cable. Double check to make sure everything is tight and properly positioned before starting the vehicle.

15. The C.A.R.B. exemption sticker, (attached), must be visible under the hood so that an emissions inspector can see it when the vehicle is required to be tested for emissions. California requires testing every two years, other states may vary.

16. It will be necessary for all K&N® custom air cleaners to be checked periodically for realignment, clearance and tightening of all connections. Failure to follow the above instructions or proper maintenance may void warranty.

ROAD TESTING:

1. Start the engine with the transmission in neutral. Listen for air leaks or odd noises. For air leaks secure hoses and connections. For odd noises, find cause and repair before proceeding. This kit will function identically to the factory system except for being louder and much more responsive.

2. Test ride the vehicle. Listen for odd noises or rattles and fix as necessary.

3. If road test is fine, you can now enjoy the added power and performance from your kit.

4. K&N Engineering, Inc., requires cleaning the intake system's air filter element every 50,000 miles. When used in dusty or off-road environments, our filters will require cleaning more often. We recommend that you visually inspect your filter once every 25,000 miles to determine if the screen is still visible. When the screen is no longer visible some place on the filter element, it is time to clean it. To clean and re-oil, purchase our filter Recharger® service kit, part number 99-5050 or 99-5000 and follow the easy instructions.

INTAKE SYSTEMS FOR VEHICLES LISTED ARE 50 STATE LEGAL. SEE KNFILTERS.COM FOR CARB STATUS ON EACH PART FOR A SPECIFIC VEHICLE.