



INTAKE SYSTEMS FOR VEHICLES LISTED ARE 50 STATE LEGAL. SEE KNFILTERS.COM FOR CARB STATUS ON EACH PART FOR A SPECIFIC VEHICLE.

INSTALLATION INSTRUCTIONS

57-9012
TOYOTA
1995-99 Tacoma
L4-2.4L / 2.7L
1995-99 4Runner
L4-2.7L

NOTE: This kit was not designed to fit vehicles with a body lift.

TOOLS NEEDED:

- Phillips Screwdriver
- Pair of Pliers
- 5mm Allen Wrench
- 10mm Wrench
- Ratchet
- Socket Extension
- 12mm Socket
- 13mm Socket
- Drill
- 3/4" Drill Bit

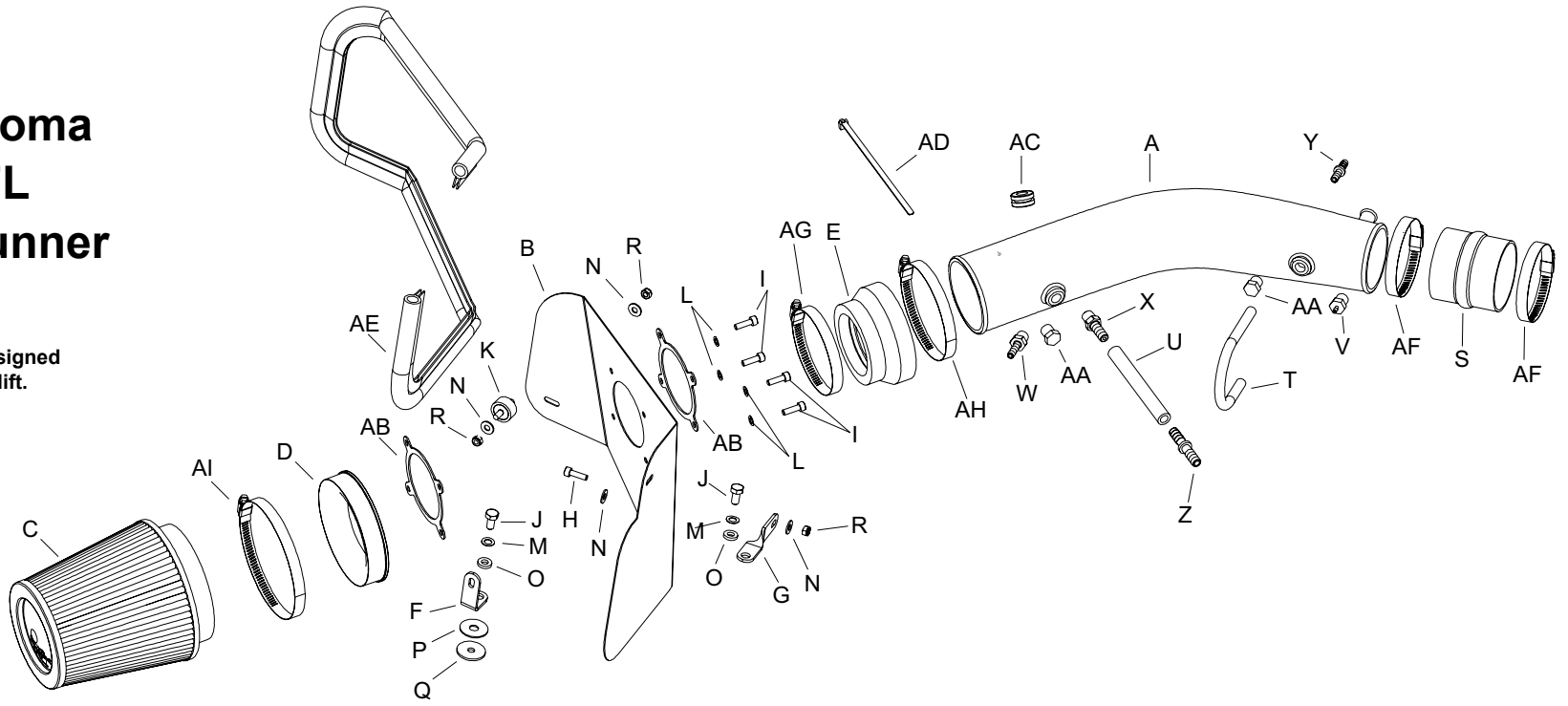

PARTS LIST:

Description	Qty.	Part #	Description	Qty.	Part #	Description	Qty.	Part #
A Intake tube	1	08739	M 8mm wave washer	2	08239	Y 1/4" hose mender	1	08046
B Heat shield	1	07412	N 1/4" id x 5/8" od flat washer	4	08275	Z 3/8" hose mender	1	08041
C Air Filter	1	RF-1037	O 5/16" id x 5/8" od flat washer	2	08276	AA Plastic plug	2	08032
D Mass air adapter	1	08781A	P Fender washer	1	08130	AB Gasket	2	09040
E Tube adapter	1	21556-1	Q Rubber washer	1	21708	AC Grommet	1	08064
F "L" bracket	1	070712	R Nylock nut	3	07553	AD Cable tie	1	21591
G Twist bracket	1	070702	S Hump Hose	1	08421	AE Trim seal 44"L	1	102486
H 6mm x 16mm Allen bolt	1	07818	T 1/4" id vent hose	1	08693	AF Hose clamp # 48	2	08601
I 6mm x 20mm Allen bolt	4	07852	U 3/8" id vent hose	1	08717	AG Hose clamp # 56	1	08620
J Hex bolt	2	07844	V 1/4 NPT x 1/8" barbed vent	1	08052	AH Hose clamp # 64	1	08648
K Rubber mounted stud	1	07027	W 1/4 NPT x 1/4" barbed vent	1	08042	AI Hose clamp # 80	1	08694
L 6mm wave washer	4	08174	X 1/4 NPT x 3/8" barbed vent	1	08047			

If you need any assistance please call 1-800-858-3333 to speak with a representative in our Customer Service Center before returning the product.

NOTE: FAILURE TO FOLLOW INSTALLATION INSTRUCTIONS AND NOT USING THE PROVIDED HARDWARE MAY DAMAGE THE INTAKE TUBE, THROTTLE BODY AND ENGINE.

TO START:

1. Turn off the ignition and disconnect the negative battery cable.
NOTE: Disconnecting the negative battery cable erases pre-programmed electronic memories. Write down all memory settings before disconnecting the negative battery cable. Some radios will require an anti-theft code to be entered after the battery is reconnected. The anti-theft code is typically supplied with your owner's manual. In the event your vehicles' anti-theft code cannot be recovered, contact an authorized dealership to obtain your vehicles anti-theft code.



2. Remove the air temperature sensor from the airbox.
Note: Not all vehicles are equipped with an external air temperature sensor.



3. Disconnect the mass air sensor electrical connection.

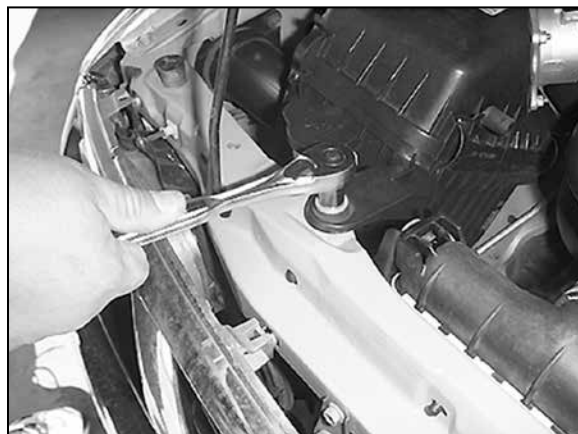

4. Loosen and remove the 3 bolts that retain the airbox.

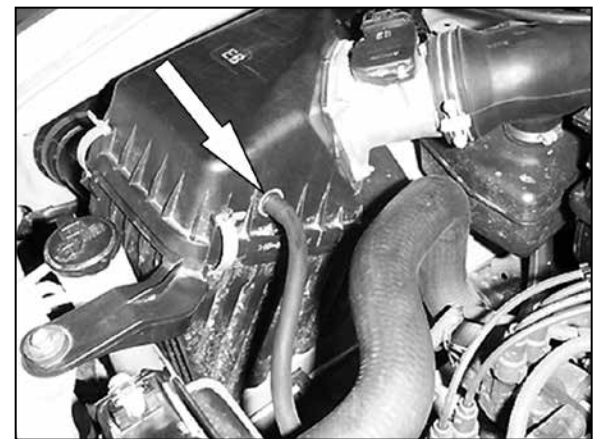

5. Disconnect the evaporative canister vent line from the airbox.
Note: Not all vehicles are equipped with an evaporative canister vent line.



6. Loosen the hose clamp on the intake hose at the mass air sensor.



7. Loosen the hose clamp on the intake hose at the intake tube.

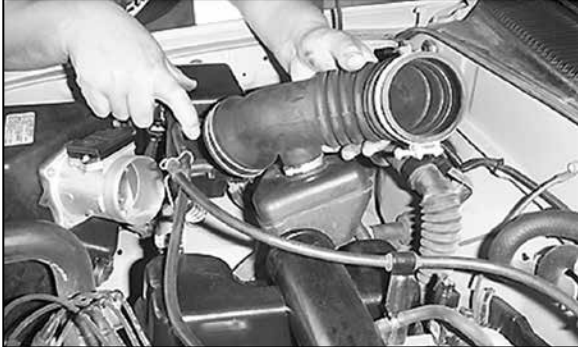

8. Detach the wiring harness and remove the intake hose.

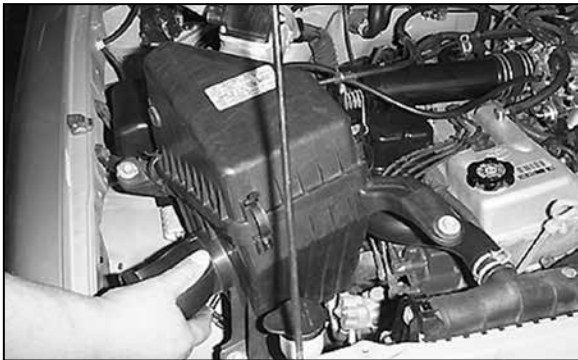

9. Remove the airbox assembly.

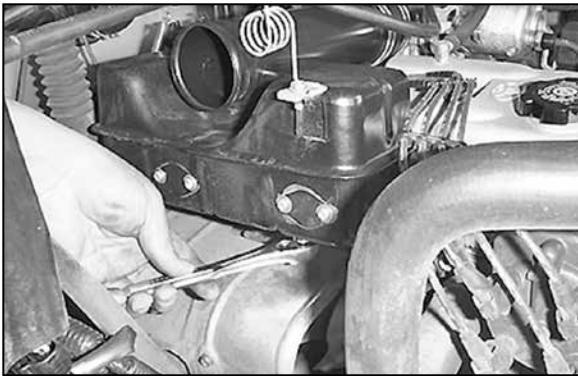

10. Loosen and remove the 2 nuts that retain the resonator assembly.

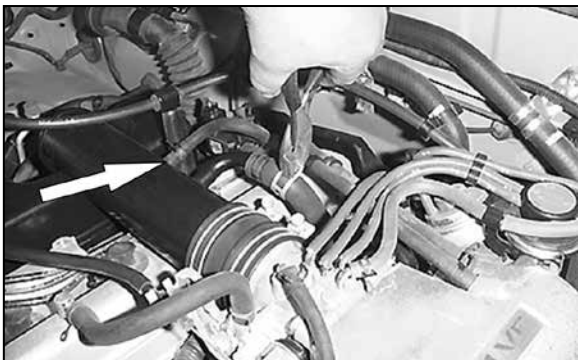

11. Disconnect the breather hose and A/C idle up magnetic valve vacuum line from the intake tube.
Note: Not all vehicles are equipped with an A/C idle up magnet valve.



12. Disconnect the fuel pressure regulator vacuum line from the resonator.
Note: Not all vehicles are equipped with a fuel pressure regulator vacuum line.

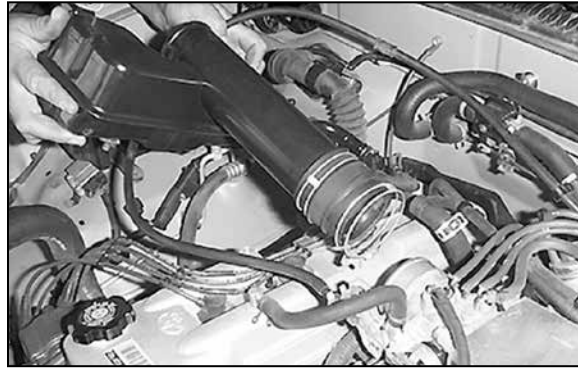

13. Loosen the hose clamp and remove the intake tube resonator assembly.
NOTE: K&N Engineering, Inc., recommends that customers do not discard factory air intake.



14. Loosen the 4 nuts and remove the mass air sensor from the airbox.



15. Assemble the mass air sensor, heat shield and mass air adapter using the gaskets and hardware provided.
Note: The adapter and gaskets have offset holes and will only line up correctly one way. It is also suggested to use medium strength thread locking compound.



16. Install the trim seal onto the heat shield.



17. Attach the "L" bracket to the rear airbox mounting point using the hardware provided.
Note: Do not tighten completely at this time.



18. Attach the rubber mounted stud to the heat shield using the hardware provided.
Note: Do not tighten completely at this time.



19. Attach the twist bracket to the front airbox mounting point on the radiator core support using the hardware provided.



20. Install the tube adapter onto the flange of the mass air sensor and tighten hose clamp provided.



21. Install the heat shield assembly and secure to the brackets using the hardware provided.

22. On models equipped with an external air temperature sensor, drill out the drill point using a 3/4" drill bit.



23. On models equipped with an external air temperature sensor, insert the grommet into the hole drilled in the previous step.



24. Install the silicone hose onto the K&N® intake tube.

25. On models equipped with an evaporative canister vent line, install the 1/4 NPT x 3/8" barbed vent into the threaded hole in the intake tube. (Item X in exploded view)
Note: On models not equipped with an evaporative canister vent line install a plastic plug provided in place of the vent. (Item AA in exploded view)

26a. On models equipped with a fuel pressure regulator vacuum line, install the 1/4 NPT x 1/8" barbed vent into the threaded hole in the intake tube. (Item V in exploded diagram)

26b. On models equipped with a A/C idle up magnetic valve vacuum line, install the 1/4 NPT x 1/8" barbed vent into the threaded hole in the intake tube. (Item W in exploded diagram)

Note: Some vehicles may not be equipped with either a fuel pressure regulator or magnet valve vacuum line in which case you will install the plastic plug provided. (Item AA in exploded diagram)

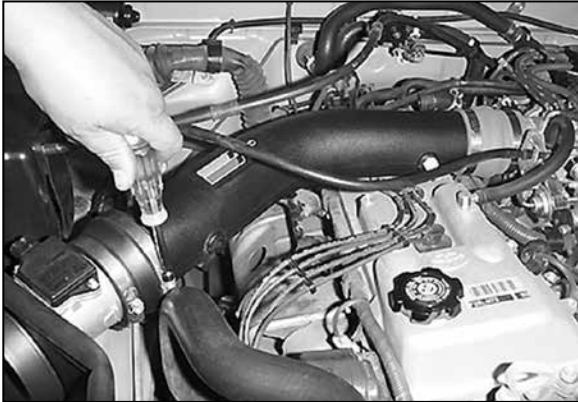

27. Install the intake tube and secure the hose clamp on the tube adapter.



28. Tighten the hose clamps on the silicone hose.

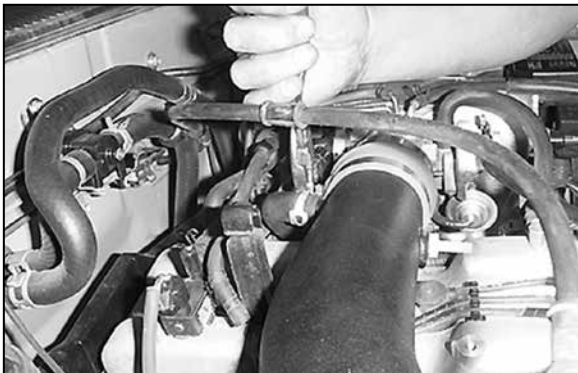

29. Attach the breather hose onto the vent on the intake tube.



30. On models equipped with an A/C idle up magnetic valve vacuum line, connect the vacuum hose disconnected in step 11 to the 1/4" id vent hose using the 1/4" hose mender provided. (Items T and Y in exploded diagram).

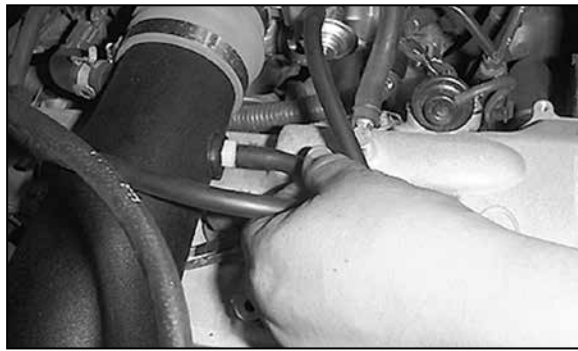

31. On models equipped with an A/C idle up magnetic valve vacuum line, attach the 1/4" id vent hose to the 1/8" barbed vent.



32. On models equipped with an evaporative canister vent line, connect the vent hose disconnected in step 5 to the 3/8" id vent hose using 3/8" hose mender provided. (Items U and Z in exploded diagram)

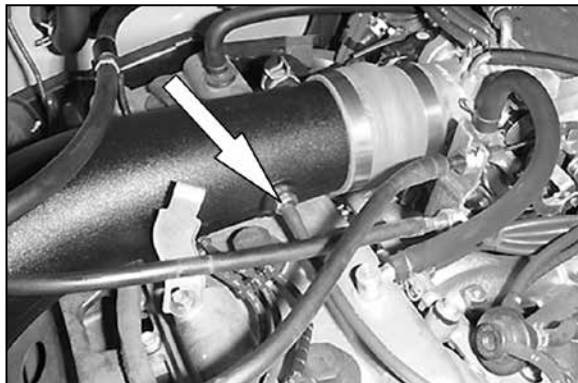

33. On models equipped with a fuel pressure regulator vacuum line attach the vacuum line to the 1/8" barbed vent.



34. On models equipped with an external air temperature sensor, insert the air temp. sensor into the grommet on the intake tube.

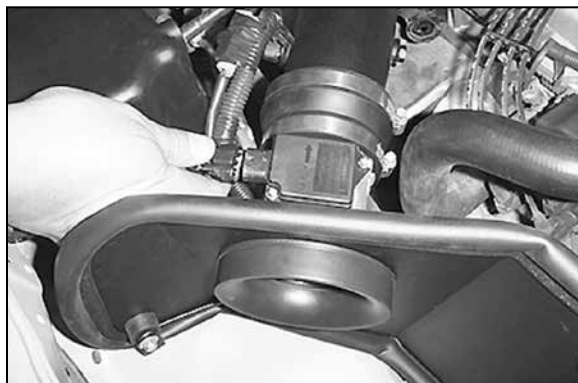

35. Reconnect the mass air sensor electrical connection.



36. Install the air filter element and tighten the hose clamp.

NOTE: Drycharger® air filter wrap; part # RF-1037DK is available to purchase separately. To learn more about Drycharger® filter wraps or look up color availability please visit <http://www.knfilters.com>®.

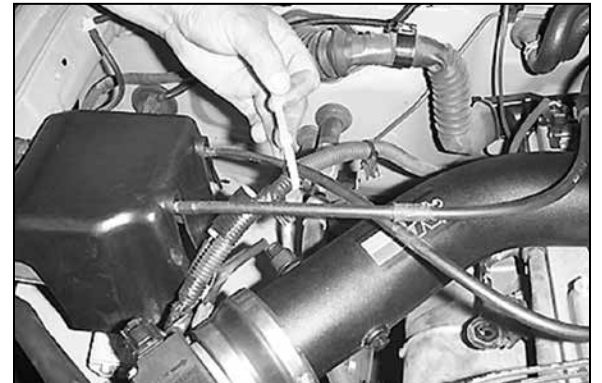

37. Secure the wiring harness to the throttle cable using the cable tie provided.

38. Reconnect the vehicle's negative battery cable. Double check to make sure everything is tight and properly positioned before starting the vehicle.

39. The C.A.R.B. exemption sticker, (attached), must be visible under the hood so that an emissions inspector can see it when the vehicle is required to be tested for emissions. California requires testing every two years, other states may vary.

40. It will be necessary for all K&N® high flow intake systems to be checked periodically for realignment, clearance and tightening of all connections. Failure to follow the above instructions or proper maintenance may void warranty.

ROAD TESTING:

1. Start the engine with the transmission in neutral or park, and the parking brake engaged. Listen for air leaks or odd noises. For air leaks secure hoses and connections. For odd noises, find cause and repair before proceeding. This kit will function identically to the factory system except for being louder and much more responsive.

2. Test drive the vehicle. Listen for odd noises or rattles and fix as necessary.

3. If road test is fine, you can now enjoy the added power and performance from your kit.

4. K&N Engineering, Inc., requires cleaning the intake system's air filter element every 100,000 miles. When used in dusty or off-road environments, our filters will require cleaning more often. We recommend that you visually inspect your filter once every 25,000 miles to determine if the screen is still visible. When the screen is no longer visible some place on the filter element, it is time to clean it. To clean and re-oil, purchase our filter Recharger® service kit, part number 99-5050 or 99-5000 and follow the easy instructions.

INTAKE SYSTEMS FOR VEHICLES LISTED ARE 50 STATE LEGAL. SEE KNFILTERS.COM FOR CARB STATUS ON EACH PART FOR A SPECIFIC VEHICLE.