



INTAKE SYSTEMS FOR VEHICLES LISTED ARE 50 STATE LEGAL. SEE KNFILTERS.COM FOR CARB STATUS ON EACH PART FOR A SPECIFIC VEHICLE.

INSTALLATION INSTRUCTIONS

57-6012
NISSAN / INFINITI
2004-14 Titan
2005-14 Armada
2004-10 QX56
2004 Pathfinder Armada
V8-5.6L

NOTE: This kit was not designed to fit vehicles with a body lift.

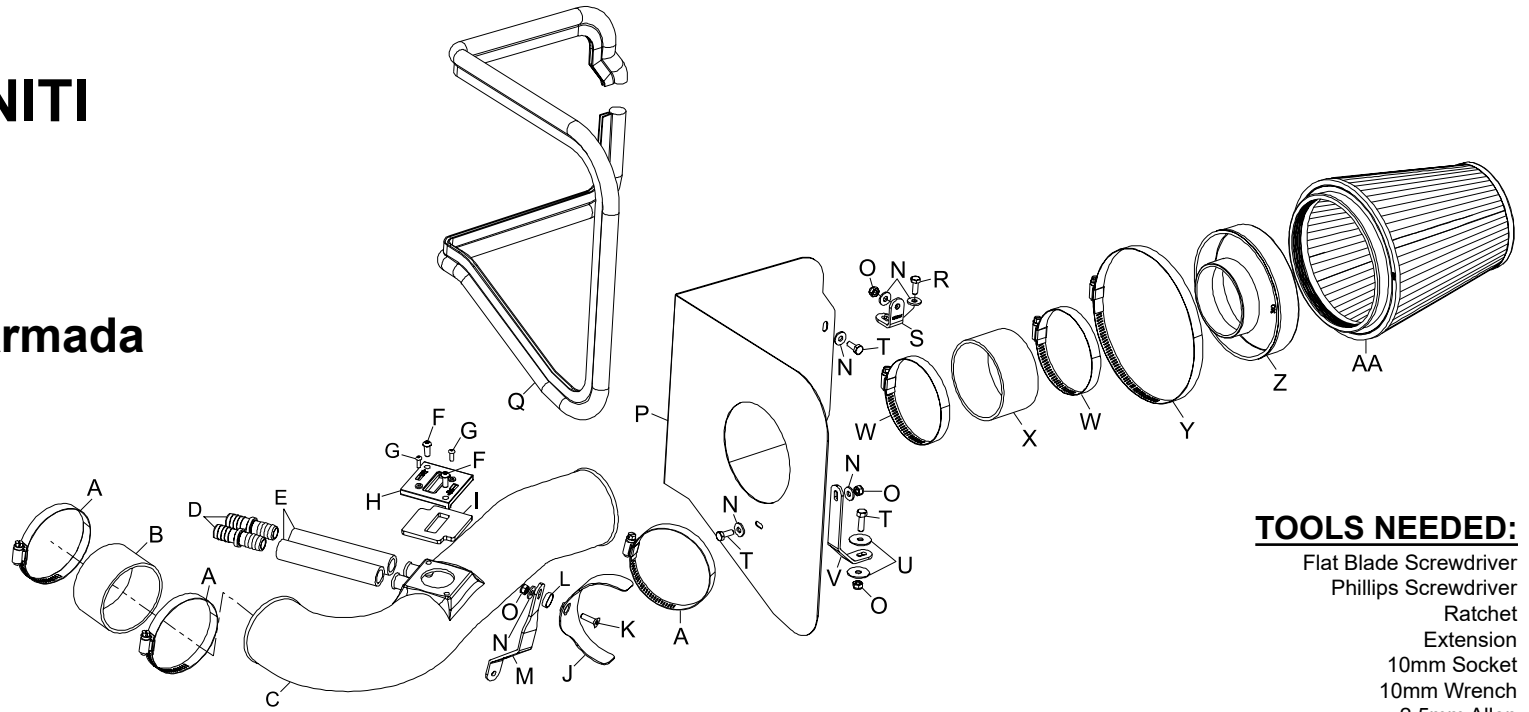

- TOOLS NEEDED:**
- Flat Blade Screwdriver
 - Phillips Screwdriver
 - Ratchet
 - Extension
 - 10mm Socket
 - 10mm Wrench
 - 2.5mm Allen
 - 4mm allen
 - Pliers

PARTS LIST:

Description	Qty.	Part #	Description	Qty.	Part #	Description	Qty.	Part #
A HOSE CLAMP #52	3	08610	J SADDLE BRACKET	1	078855	S BRACKET, SMALL "L"	1	070066
B SILICONE HOSE	1	08690	K BOLT; M6-1.00 F/H/A	1	08376	T BOLT; M6-1.00X16MM HEX	3	07703
C INTAKE TUBE	1	087109	L WASHER, CONICAL BLACK NYLON	1	08180	U WASHER, 1.0"ODX.250"ID	2	08160
D VENT	2	08048	M BRACKET "Z"	1	07191	V BRACKET	1	07190
E SILICONE HOSE 5/8"ID X 5"L	2	08538	N WASHER, .625"ODX.250"ID	6	08275	W HOSE CLAMP #56	2	08620
F BOLT; M6-1.00X16MM B/H/A	2	07730	O NUT; NYLOCK, M6	4	07553	X SILICONE HOSE	1	08630
G SCREW	2	07726	P HEAT SHIELD	1	074020	Y HOSE CLAMP #104	1	08697
H ADAPTER #420	1	21515	Q EDGE TRIM 66"	1	102472	Z FILTER ADAPTER #380	1	21512-1
I GASKET	1	09069	R BOLT; M6-1.00X20MM HEX	1	07795	AA AIR FILTER	1	RF-1044

If you need any assistance please call 1-800-858-3333 to speak with a representative in our Customer Service Center before returning the product.

NOTE: FAILURE TO FOLLOW INSTALLATION INSTRUCTIONS AND NOT USING THE PROVIDED HARDWARE MAY DAMAGE THE INTAKE TUBE, THROTTLE BODY AND ENGINE.

TO START:

1. Turn off the ignition and disconnect the negative battery cable.
NOTE: Disconnecting the negative battery cable erases pre-programmed electronic memories. Write down all memory settings before disconnecting the negative battery cable. Some radios will require an anti-theft code to be entered after the battery is reconnected. The anti-theft code is typically supplied with your owner's manual. In the event your vehicles' anti-theft code cannot be recovered, contact an authorized dealership to obtain your vehicles anti-theft code.



2. Remove the two bolts that secure the throttle body cover, then remove the throttle body cover.



3. Disconnect the mass air sensor electrical connection, then release the wire loom from the air box.

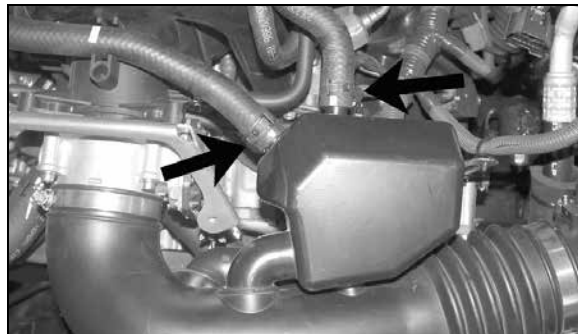

4. Remove the two vent lines from the air intake resonator as shown.



5. Loosen the hose clamps at the throttle body and air box, then remove the intake tube from the vehicle.



6. Release the two air box lid retainer clips that secure the air box lid to the air box, then remove the air box lid and air filter.
NOTE: On four wheel drive vehicles, it will be necessary to un-hook the differential vent hose from the air box lid.

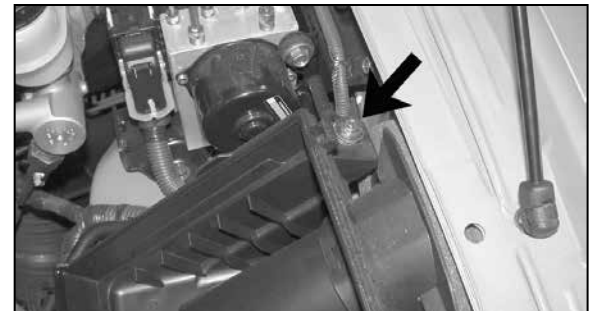

7. Remove the air box mounting bolt with a 10mm socket.



8. Pull firmly up on the air box to release it from the mounting studs, then remove the air box from the vehicle.

NOTE: K&N Engineering, Inc., recommends that customers do not discard factory air intake.

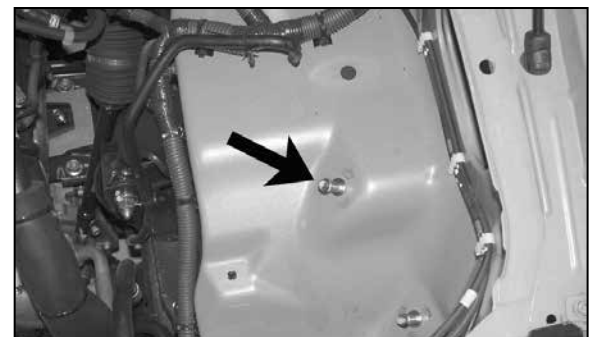

9. Remove the air box mounting stud shown with a 10mm wrench.

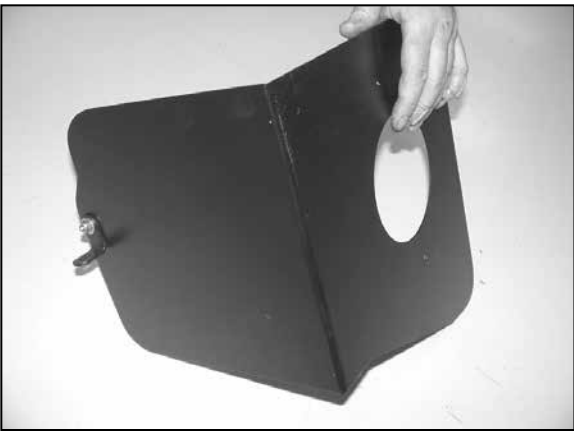

10. Install "L" bracket (#070066) onto the heat shield as shown.

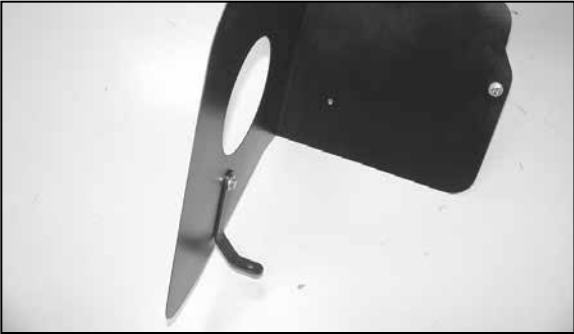

11. Install "L" bracket (07190) onto the heat shield as shown.



12. Install the edge trim onto the heat shield as shown. Trim as needed.



13. Using a screw driver, push the center of the plastic inner fender retaining clip through, then remove the clip from the inner fender.

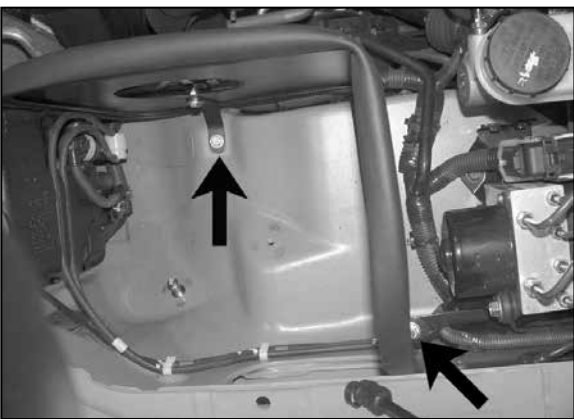

14. Install the heat shield onto the vehicle and secure with the provided hardware.

NOTE: On four wheel drive vehicles, insert differential vent retaining clip into the hole provided on the heat shield.



15. Assemble the saddle bracket assembly with the provided hardware as shown.



16. Locate the ground wire attached to the engine cam cover and remove the bolt securing it using a 10mm wrench.

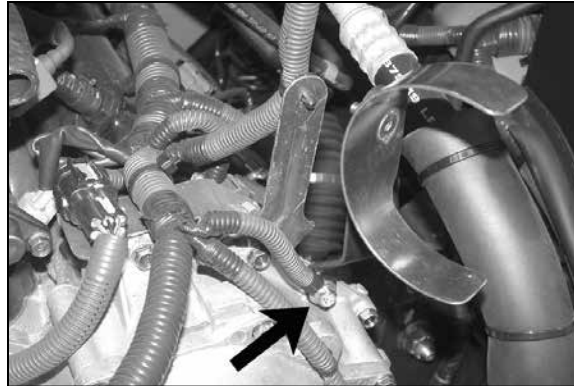

17. Install the saddle bracket assembly and ground wire removed in step #16 with the provided hardware as shown.

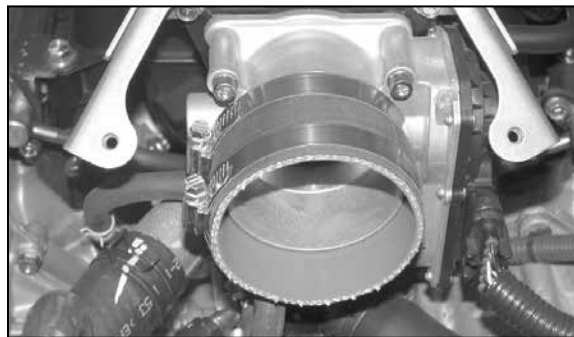

18. Install the provided silicone hose (08690) onto the throttle body with the provided hose clamps as shown.



19. Remove the two screws that secure the mass air sensor to the air box lid, then remove the mass air sensor as shown.



20. Apply the provided gasket to the mass air sensor adapter as shown; sticky side down.

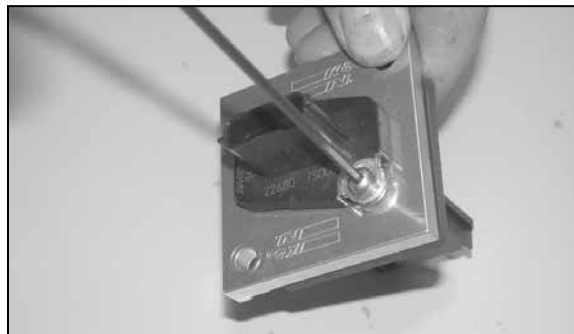

21. Insert the mass air sensor into the mass air sensor adapter and secure with the provided hardware.

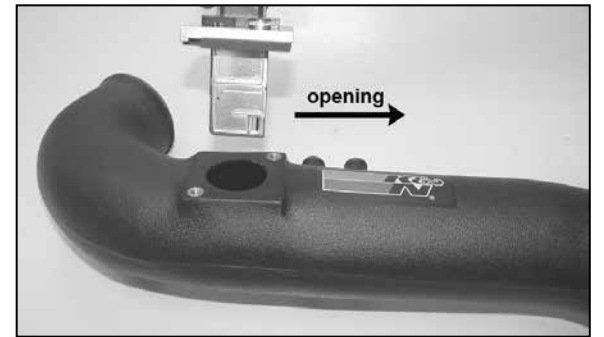

22. Install the mass air sensor assembly into the intake tube with the opening of the sensor pointing towards the air filter end of the tube as shown.

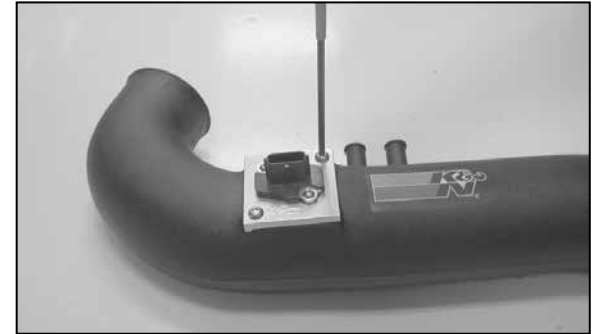

23. Secure the mass air sensor assembly onto the K&N® intake tube with the provided hardware.



24. Install the K&N® intake tube onto the throttle body and align with the saddle bracket.



25. Secure the K&N® intake tube to the saddle bracket with the provided hose clamp. Also tighten the hose clamp at the throttle body.

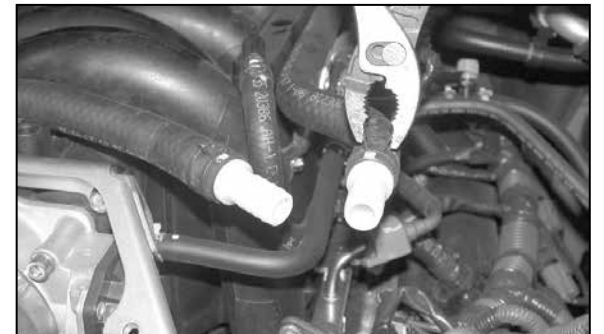

26. Install the provided hose mender into the two crank case vent hoses and secure the existing spring clamps as shown.



27. Install the provided silicone hose onto the hose mender, then install the hoses onto the intake tube as shown.

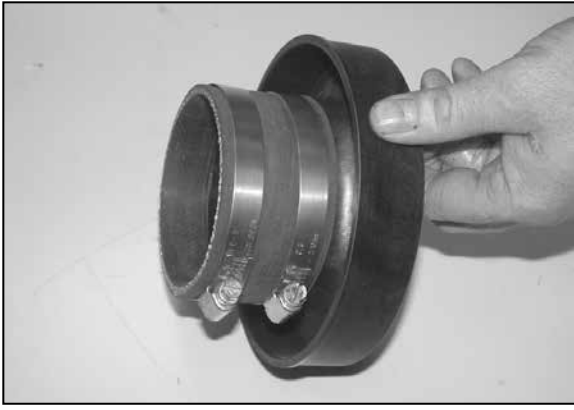

28. Install the provided silicone hose (#08630) onto the filter adapter as shown.



29. Install the filter adapter assembly into the K&N® air filter.



30. Install the K&N® air filter assembly onto the K&N® intake tube as shown; secure with the provided hose clamp.



31. Reconnect the mass air sensor electrical connection.



32. Re-install the throttle body cover as shown.



33. Reconnect the vehicle's negative battery cable. Double check to make sure everything is tight and properly positioned before starting the vehicle.

34. The C.A.R.B. exemption sticker, (attached), must be visible under the hood so that an emissions inspector can see it when the vehicle is required to be tested for emissions. California requires testing every two years, other states may vary.

35. It will be necessary for all K&N® high flow intake systems to be checked periodically for realignment, clearance and tightening of all connections. Failure to follow the above instructions or proper maintenance may void warranty.

ROAD TESTING:

1. Start the engine with the transmission in neutral or park, and the parking brake engaged. Listen for air leaks or odd noises. For air leaks secure hoses and connections. For odd noises, find cause and repair before proceeding. This kit will function identically to the factory system except for being louder and much more responsive.

2. Test drive the vehicle. Listen for odd noises or rattles and fix as necessary.

3. If road test is fine, you can now enjoy the added power and performance from your kit.

4. K&N Engineering, Inc., requires cleaning the intake system's air filter element every 100,000 miles. When used in dusty or off-road environments, our filters will require cleaning more often. We recommend that you visually inspect your filter once every 25,000 miles to determine if the screen is still visible. When the screen is no longer visible some place on the filter element, it is time to clean it. To clean and re-oil, purchase our filter Recharger® service kit, part number 99-5050 or 99-5000 and follow the easy instructions.

INTAKE SYSTEMS FOR VEHICLES LISTED ARE 50 STATE LEGAL. SEE KNFILTERS.COM FOR CARB STATUS ON EACH PART FOR A SPECIFIC VEHICLE.